



6EU8-5EU8 TRIODE-PENTODE

6EU8
5EU8
ET-T1587
Page 1
12-59

FOR VHF CONVERTER APPLICATIONS

DESCRIPTION AND RATING

The 6EU8 is a miniature, triode-pentode primarily intended for service as a combined triode oscillator and pentode mixer in television receivers. Except for heater ratings, the 5EU8 is identical to the 6EU8. Both tubes incorporate a controlled heater-warm-up characteristic.

GENERAL

ELECTRICAL

Cathode—Coated Unipotential

Heater Voltage, AC or DC. 4.7

Heater Current. $0.6 \pm 5\%$

Heater Warm-up Time*. 11

Direct Interelectrode Capacitances

Pentode Section

Grid-Number 1 to Plate: (Pg1 to Pp), maximum. . . 0.01

Input: Pg1 to (h+Pk+Pg2+Pg3+i.s.). 5.0

Output: Pp to (h+Pk+Pg2+Pg3+i.s.). 3.4

Heater to Cathode: (Pk to h). $3.0 \ddagger$

Triode Section

Grid to Plate: (Tg to Tp). 1.7

Input: Tg to (Tk+h+Pk+Pg3+i.s.). 3.2

Output: Tp to (Tk+h+Pk+Pg3+i.s.). 2.1

Heater to Cathode: (Pk to h). $3.0 \ddagger$

MECHANICAL

Mounting Position—Any

Envelope—T-6½, Glass

Base—E9-1, Small Button 9-Pin

5EU8

6EU8

6.3 Volts

$0.45 \pm 6\%$ Amperes

11 Seconds

With Shield†

Without Shield

0.02 $\mu\mu\text{f}$

5.0 $\mu\mu\text{f}$

2.6 $\mu\mu\text{f}$

3.0 $\mu\mu\text{f}$

1.7 $\mu\mu\text{f}$

3.0 $\mu\mu\text{f}$

1.6 $\mu\mu\text{f}$

3.0 $\mu\mu\text{f}$

BASING DIAGRAM

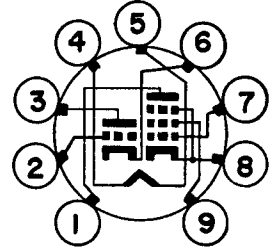

EIA 9JF

TERMINAL CONNECTIONS

- Pin 1—Pentode Plate
- Pin 2—Triode Grid
- Pin 3—Triode Plate
- Pin 4—Heater
- Pin 5—Heater
- Pin 6—Triode Cathode
- Pin 7—Pentode Grid Number 1
- Pin 8—Pentode Cathode, Grid Number 3, and Internal Shield
- Pin 9—Pentode Grid Number 2 (Screen)

PHYSICAL DIMENSIONS

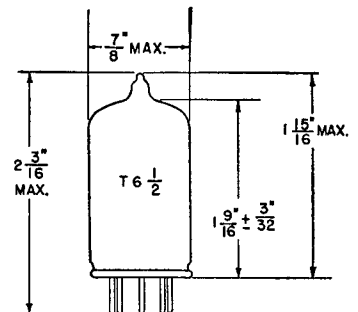

EIA 6-2

The tubes and arrangements disclosed herein may be covered by patents of General Electric Company or others. Neither the disclosure of any information herein nor the sale of tubes by General Electric Company conveys any license under patent claims covering combination of tubes with other devices or elements. In the absence of an express written agreement to the contrary, General Electric Company assumes no liability for patent infringement arising out of any use of the tubes with other devices or elements by any purchaser of tubes or others.

MAXIMUM RATINGS

DESIGN-MAXIMUM VALUES

	Pentode Section	Triode Section
Plate Voltage	330	330 Volts
Screen Supply Voltage	330	. . . Volts
Positive DC Grid-Number 1 Voltage	0	0 Volts
Plate Dissipation	3.1	3.0 Watts
Screen Dissipation	0.55	. . . Watts
Heater-Cathode Voltage		
Heater Positive with Respect to Cathode		
DC Component	100	100 Volts
Total DC and Peak	200	200 Volts
Heater Negative with Respect to Cathode		
Total DC and Peak	200	200 Volts
Grid-Number 1 Circuit Resistance	0.1	0.1 Megohms

Design-Maximum ratings are limiting values of operating and environmental conditions applicable to a bogey tube of a specified type as defined by its published data, and should not be exceeded under the worst probable conditions.

These values are chosen by the tube manufacturer to provide acceptable serviceability of the tube, taking responsibility for the effects of changes in operating conditions due to variations in the characteristics of the tube under consideration.

The equipment manufacturer should design so that initially and throughout life no design-maximum value for the intended service is exceeded with a bogey tube under the worst probable operating conditions with respect to supply-voltage variation, equipment component variation, variation in characteristics of all other tubes in the equipment, equipment control adjustment, load variation, signal variation, and environmental conditions.

CHARACTERISTICS AND TYPICAL OPERATION

AVERAGE CHARACTERISTICS

	Pentode Section	Triode Section
Plate Voltage	125	150 Volts
Screen Voltage	125	. . . Volts
Grid-Number 1 Voltage	-1.0	. . . Volts
Cathode-Bias Resistor		56 Ohms
Amplification Factor		40
Plate Resistance, approximate	80000	5000 Ohms
Transconductance	6400	8500 Micromhos
Plate Current	12	18 Milliampers
Screen Current	4.0	. . . Milliampers
Grid-Number 1 Voltage, approximate		
I _b = 10 Microampers	-9	-12 Volts

* The time required for the voltage across the heater to reach 80 percent of its rated value after applying 4 times rated heater voltage to a circuit consisting of the tube heater in series with a resistance equal to 3 times the rated heater voltage divided by the rated heater current.

† With external shield (EIA 315) connected to cathode of section under test unless otherwise indicated.

‡ With external shield (EIA 315) connected to ground.

SCREEN RATING CHART

PENTODE SECTION

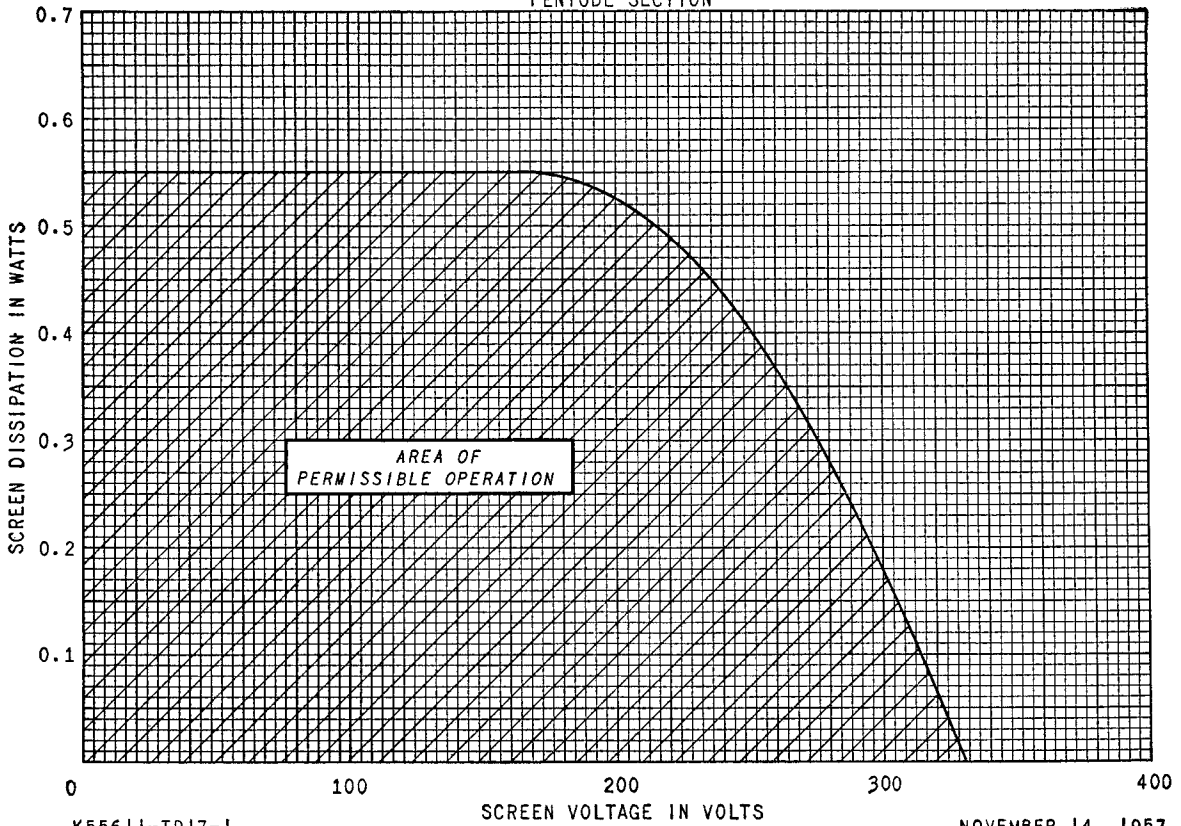

AVERAGE PLATE CHARACTERISTICS

PENTODE SECTION

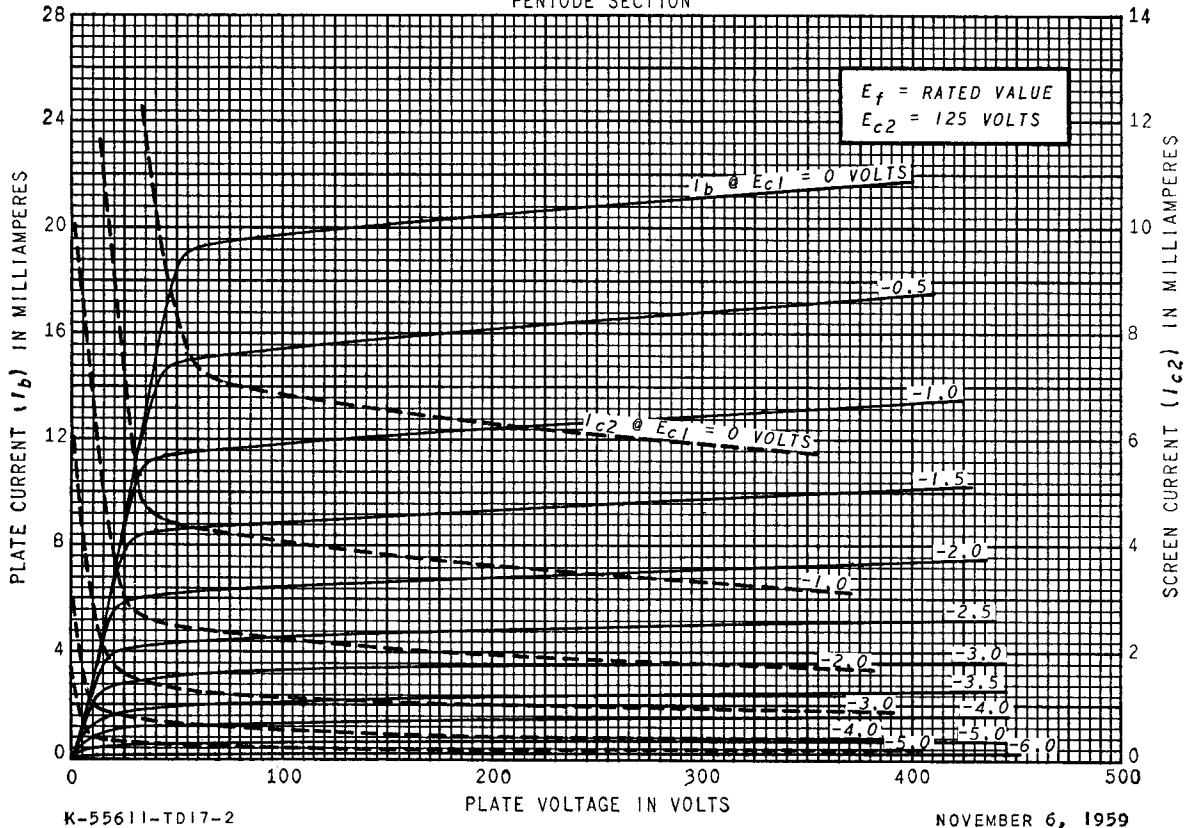

AVERAGE PLATE CHARACTERISTICS
 PENTODE SECTION

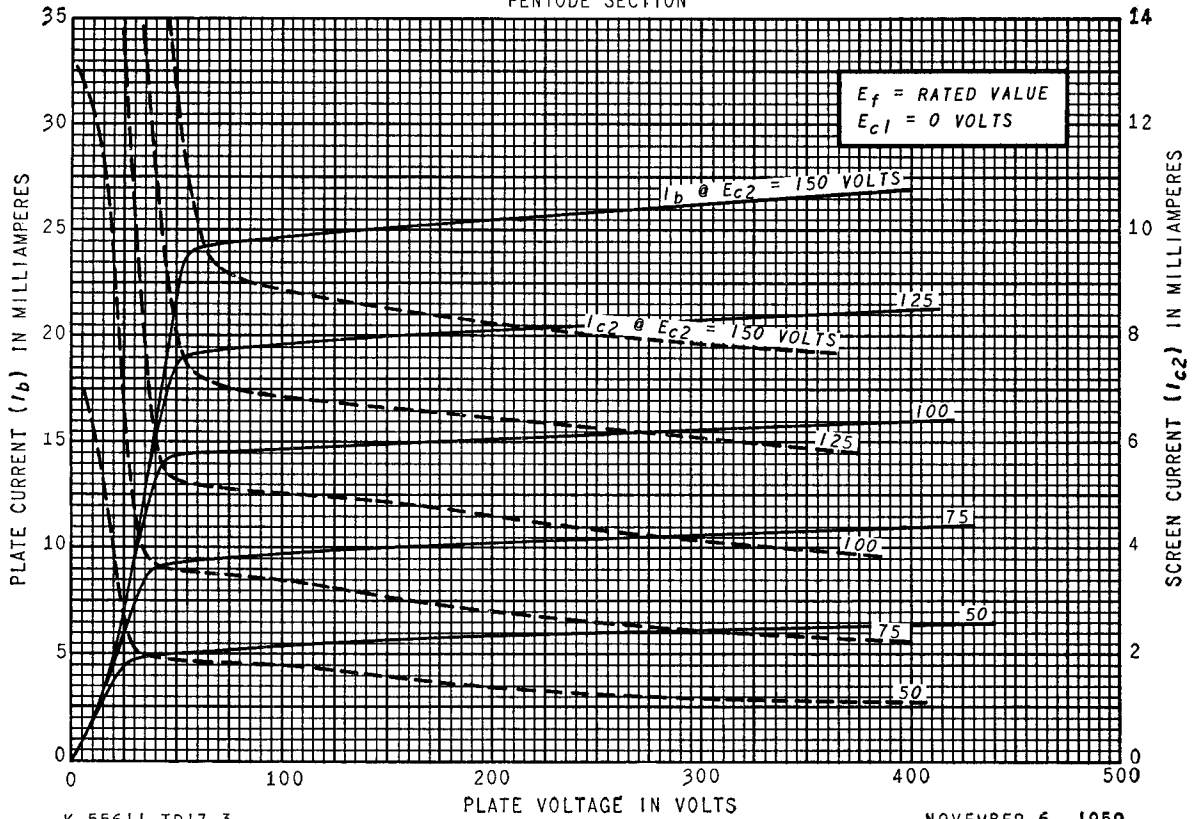

K-55611-TD17-3

NOVEMBER 6, 1959

AVERAGE TRANSFER CHARACTERISTICS
 PENTODE SECTION

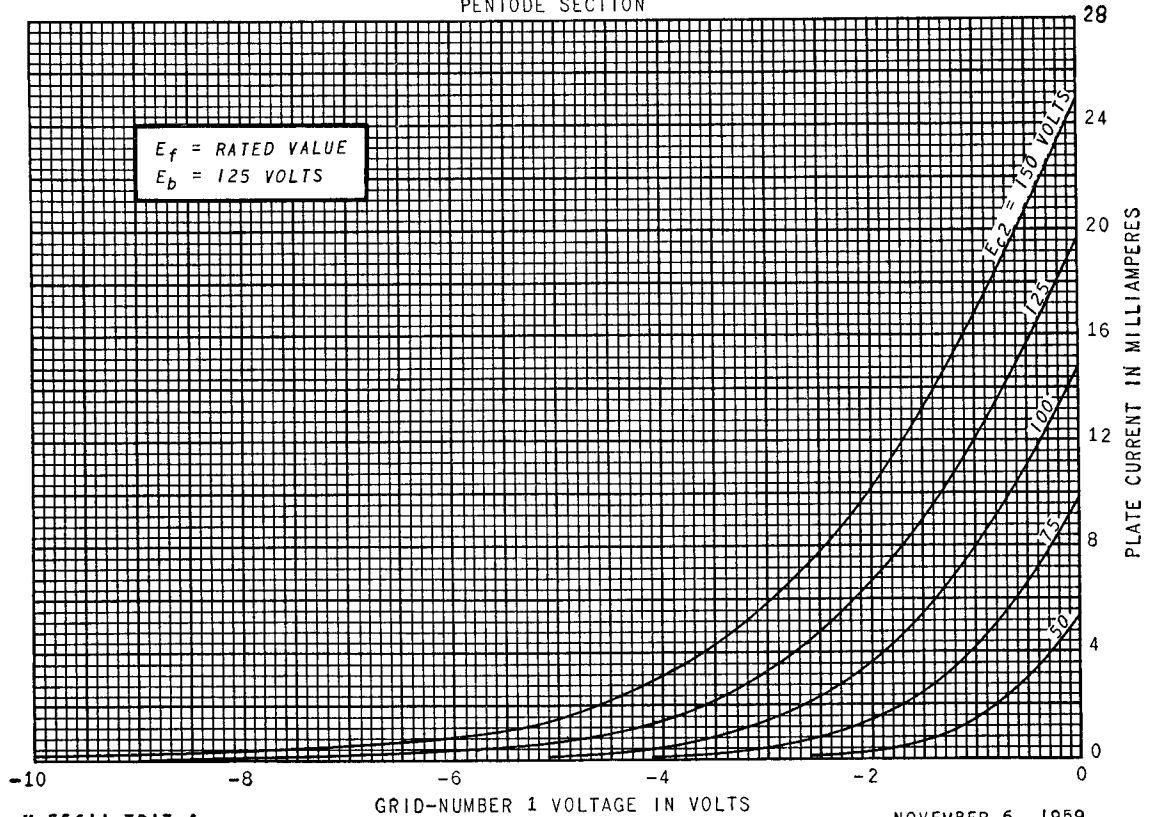

K-55611-TD17-4

NOVEMBER 6, 1959

AVERAGE TRANSFER CHARACTERISTICS PENTODE SECTION

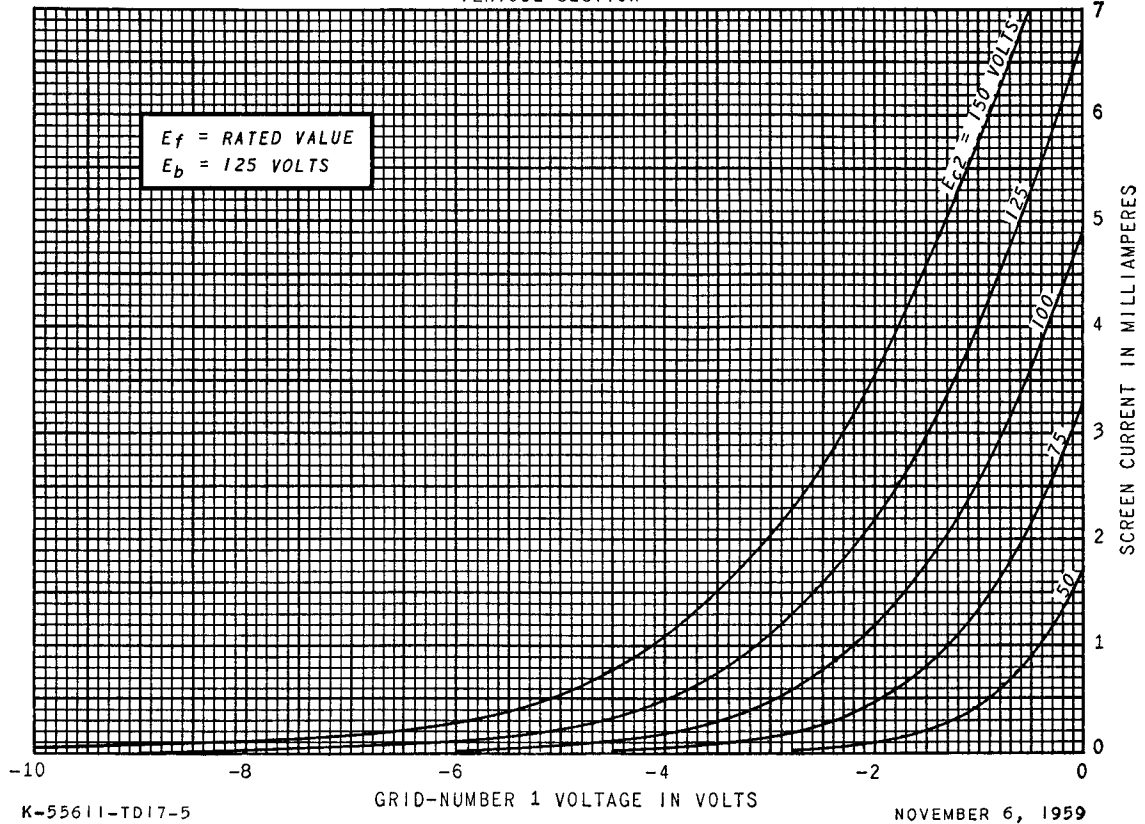

AVERAGE TRANSFER CHARACTERISTICS PENTODE SECTION

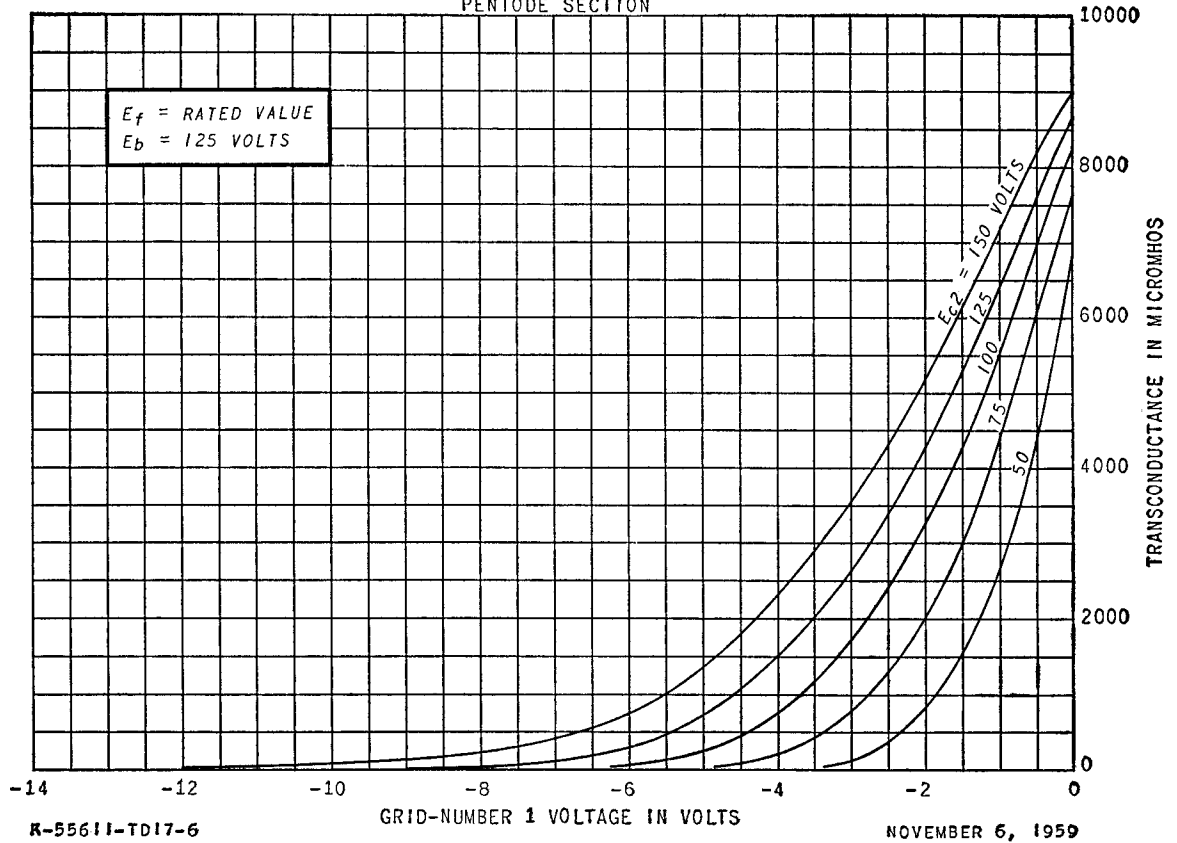

AVERAGE PLATE CHARACTERISTICS

TRIODE SECTION

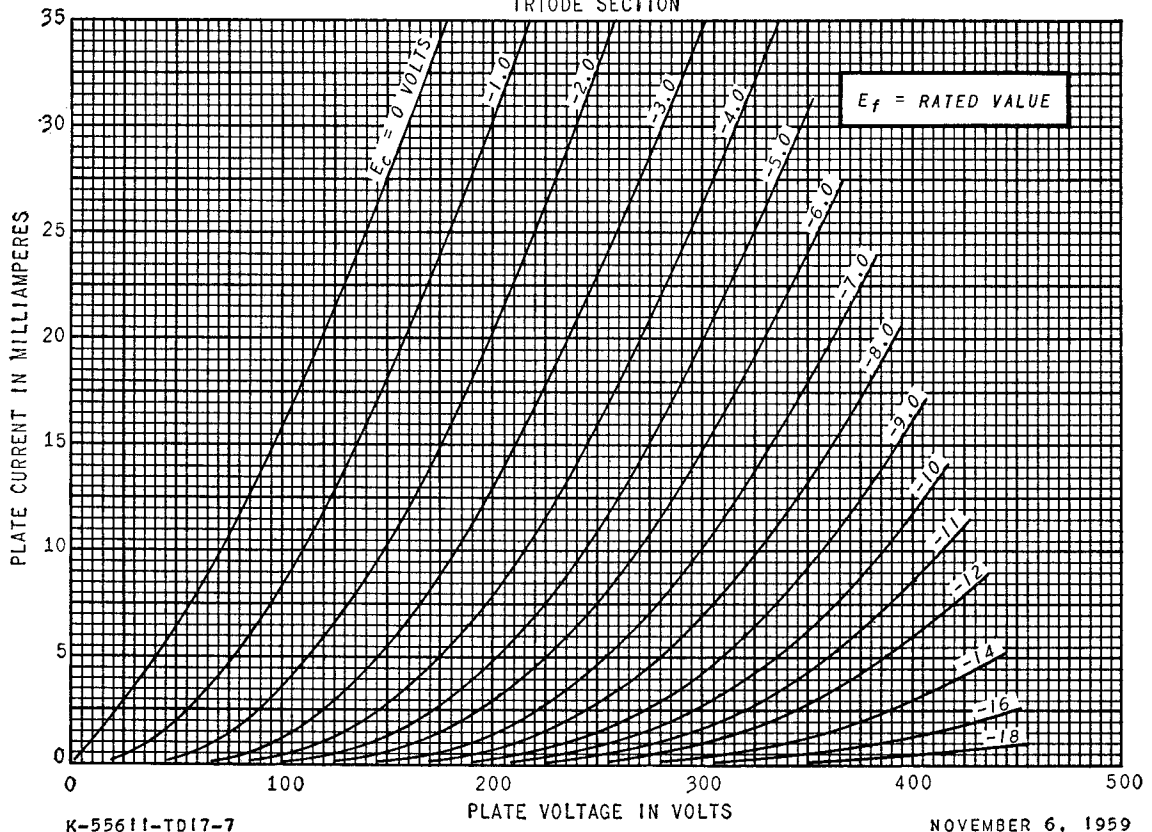

K-55611-TD17-7

NOVEMBER 6, 1959

AVERAGE TRANSFER CHARACTERISTICS

TRIODE SECTION

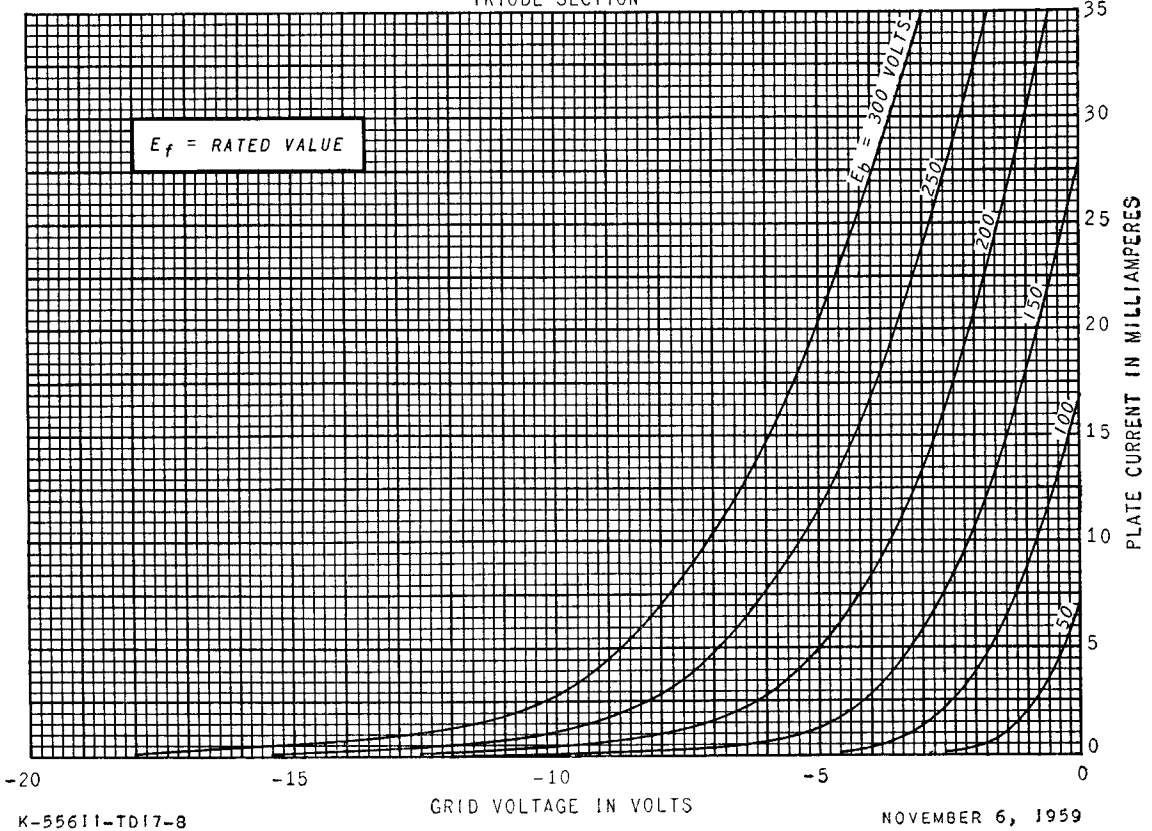

K-55611-TD17-8

NOVEMBER 6, 1959

AVERAGE CHARACTERISTICS
 TRIODE SECTION

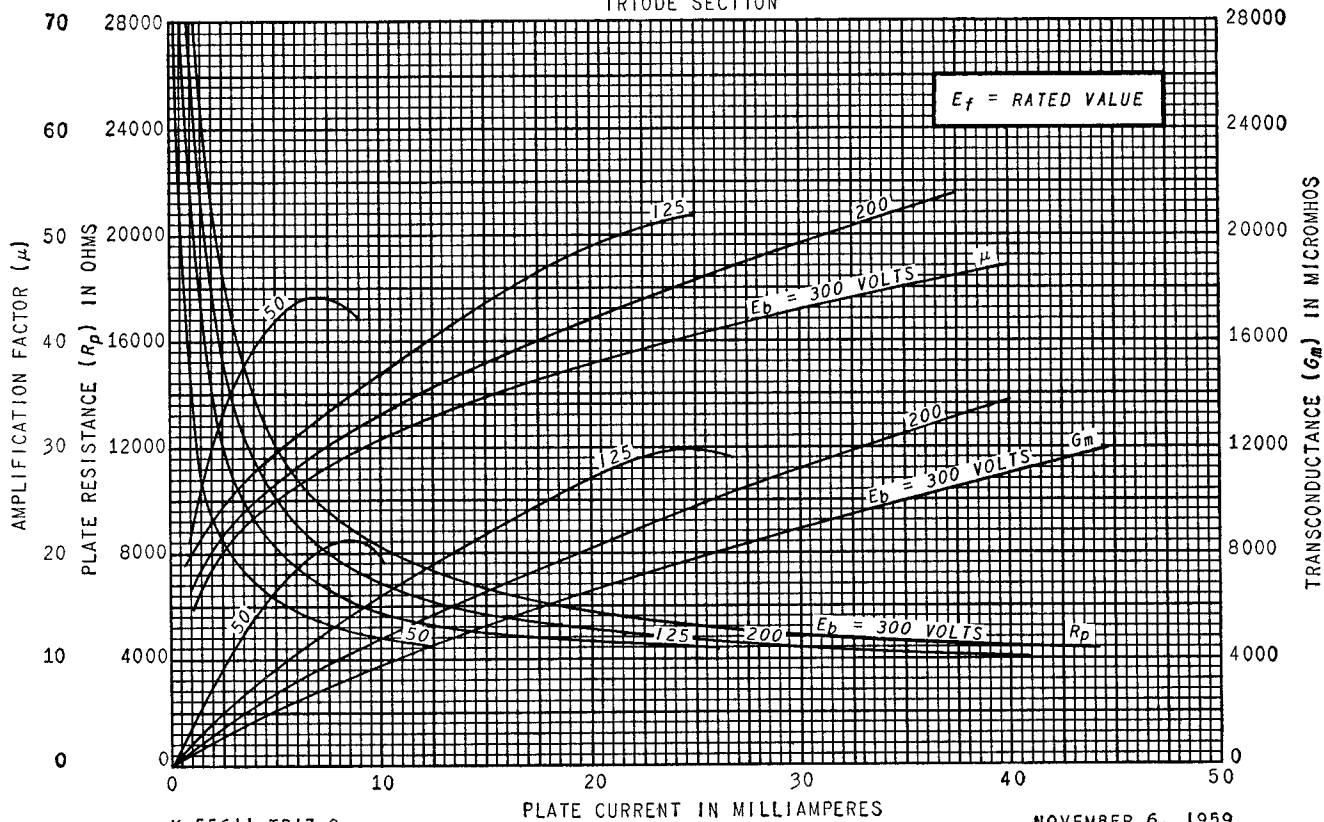

K-55611-TD17-9

NOVEMBER 6, 1959